

SECTION DETAIL 1 1/2"=1'-0" 20

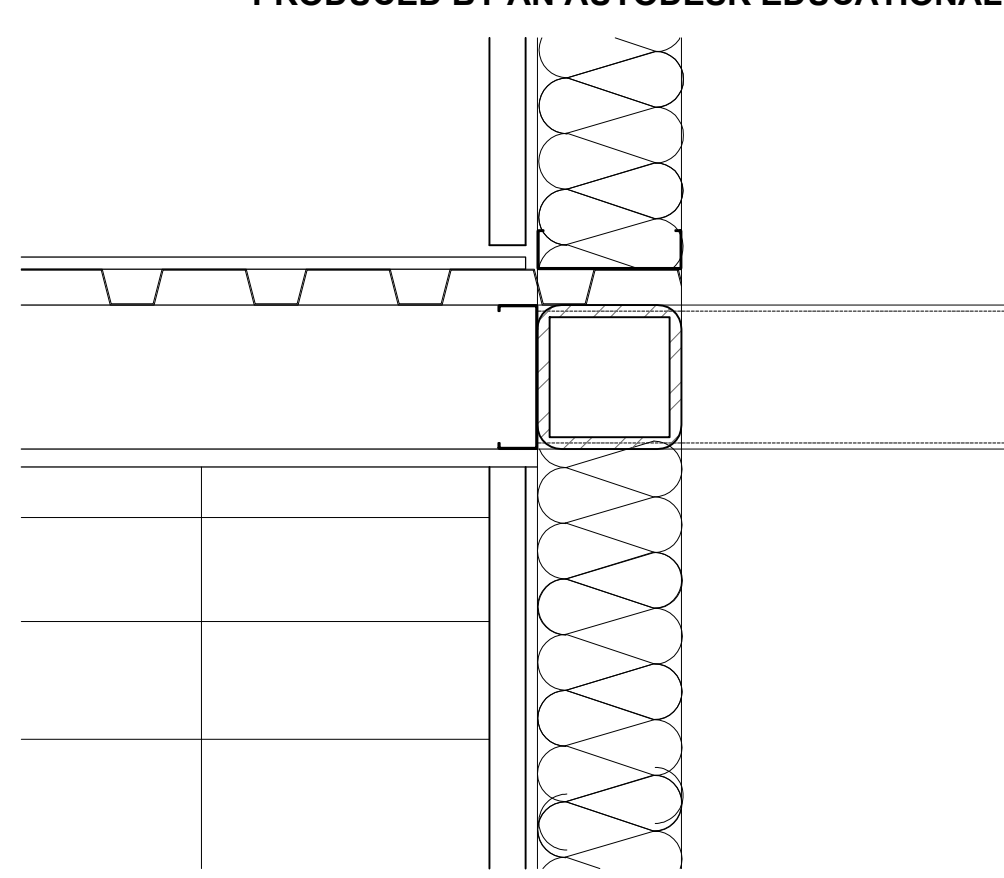

SECTION DETAIL 1 1/2"=1'-0" 16

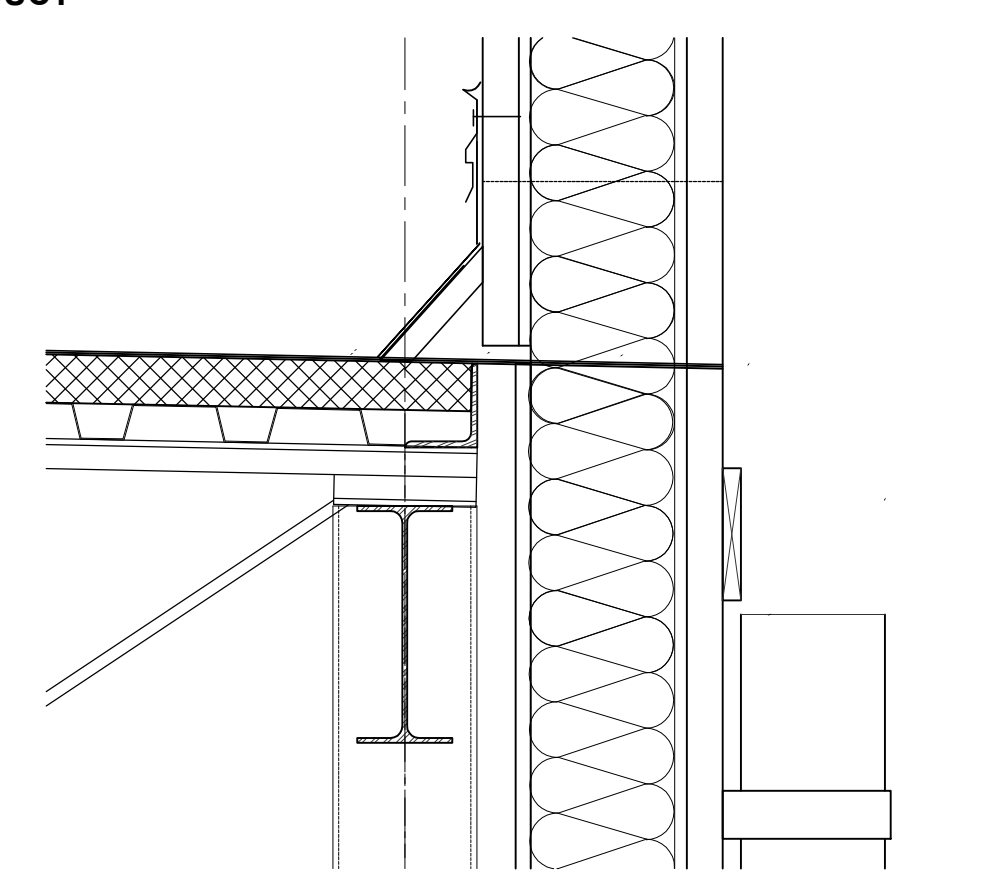

SECTION DETAIL 1 1/2"=1'-0" 12

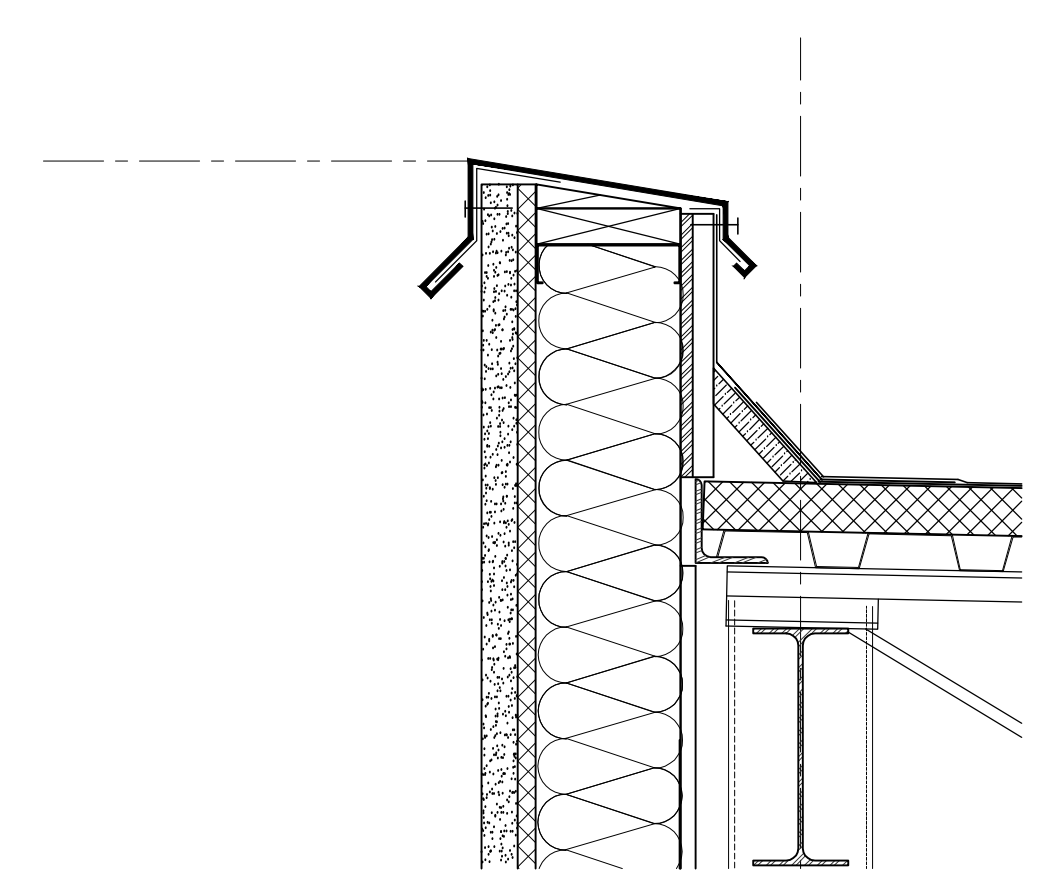

SECTION DETAIL 1 1/2"=1'-0" 8

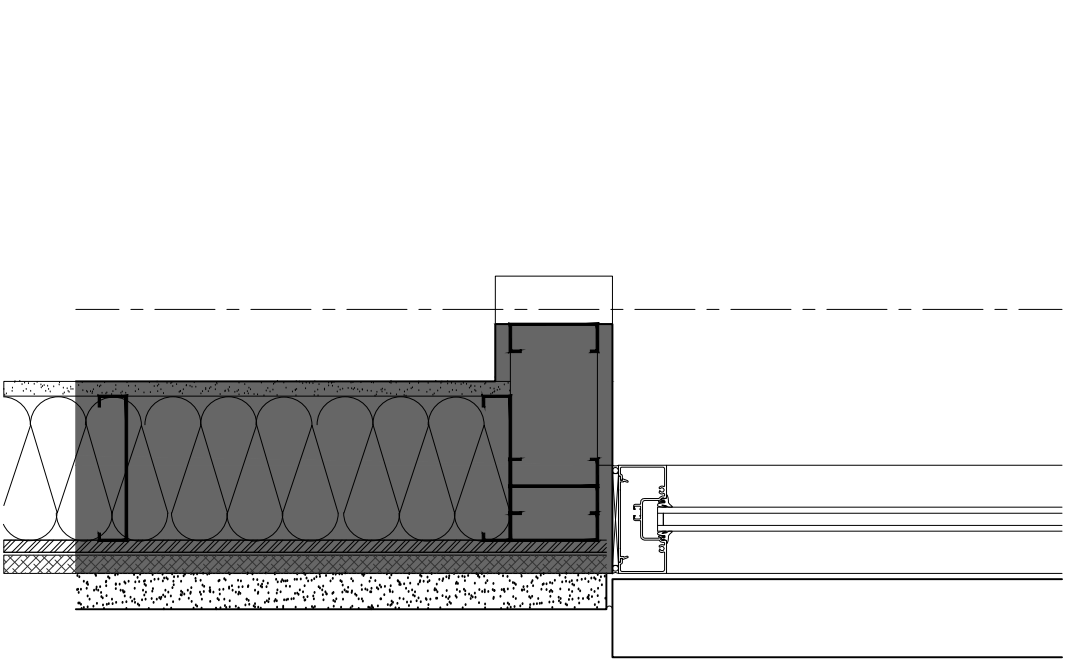

SECTION DETAIL 1 1/2"=1'-0" 19

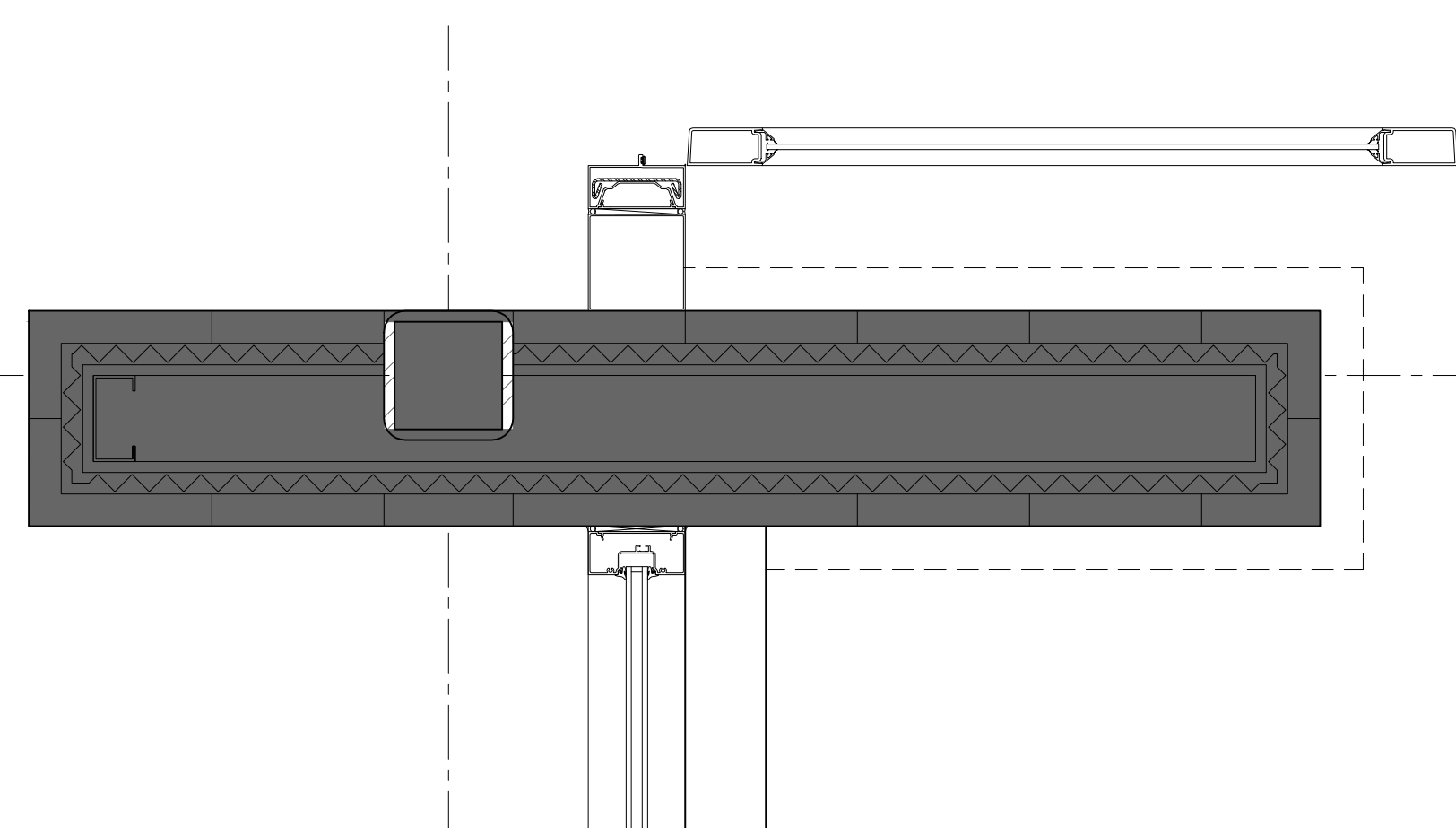

SECTION DETAIL 1 1/2"=1'-0" 15

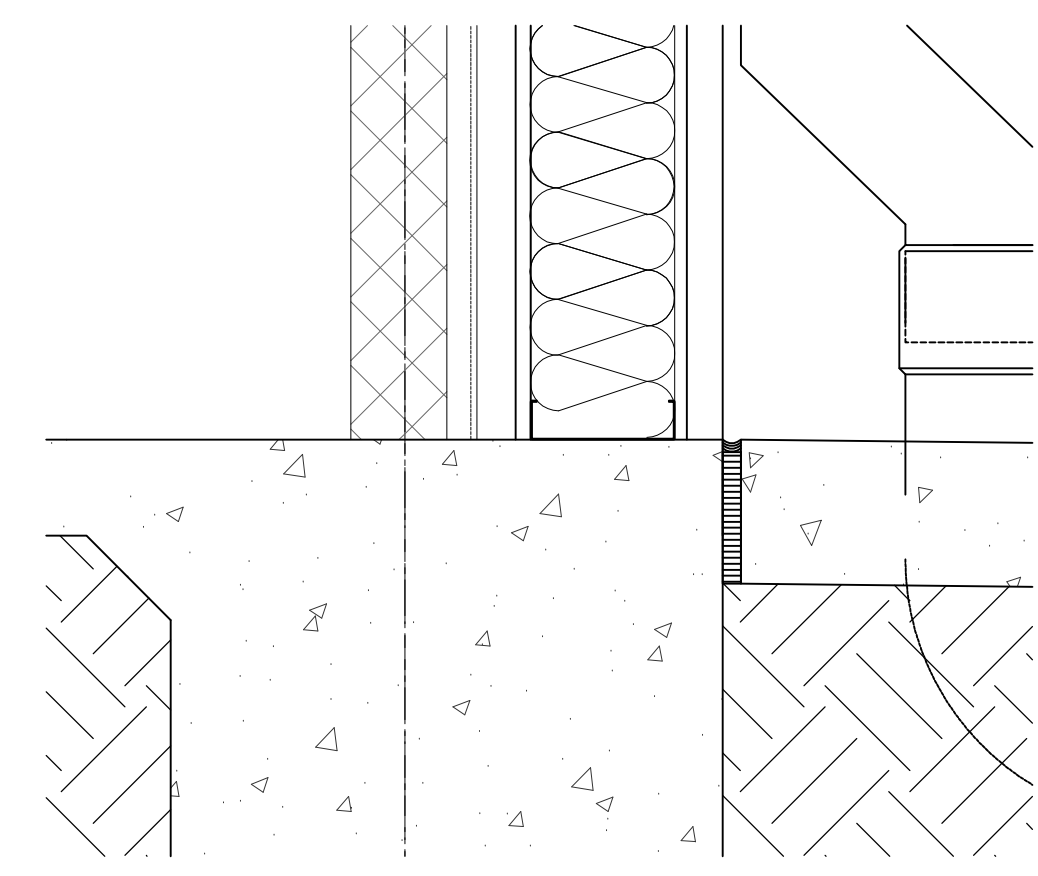

SECTION DETAIL 1 1/2"=1'-0" 11

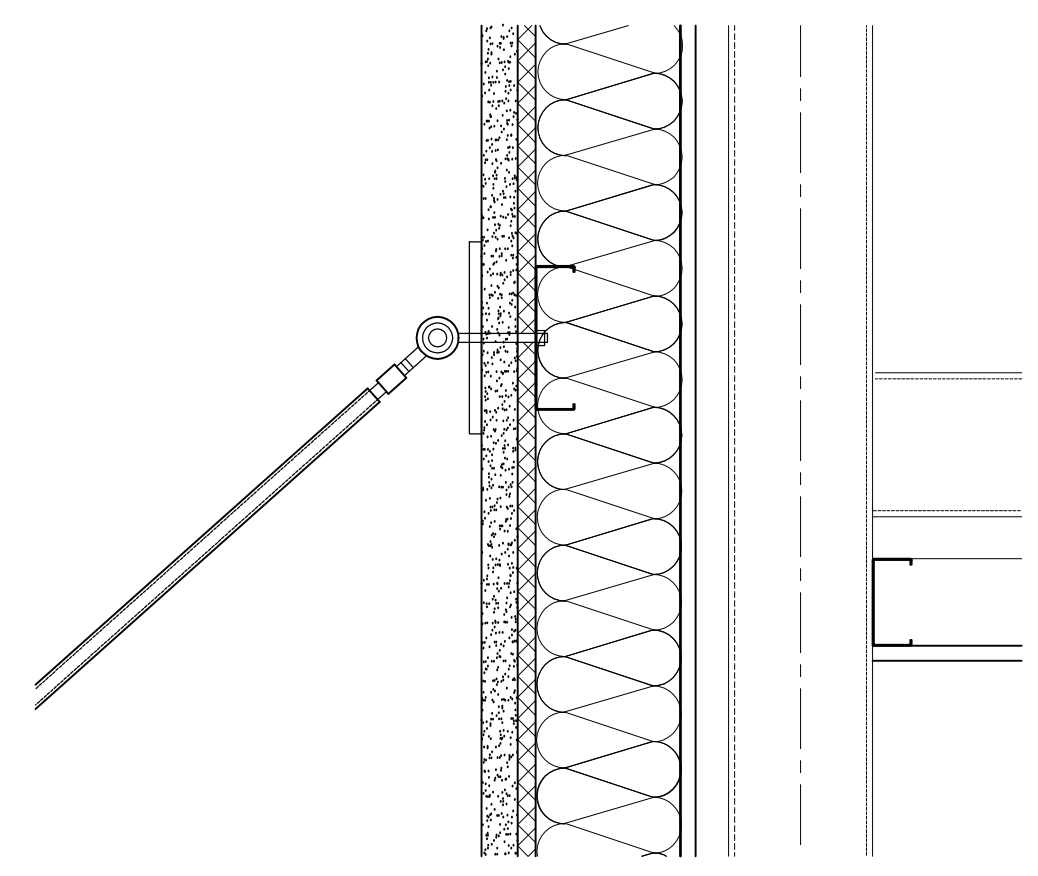

SECTION DETAIL 1 1/2"=1'-0" 7

SECTION DETAIL 1 1/2"=1'-0" 3

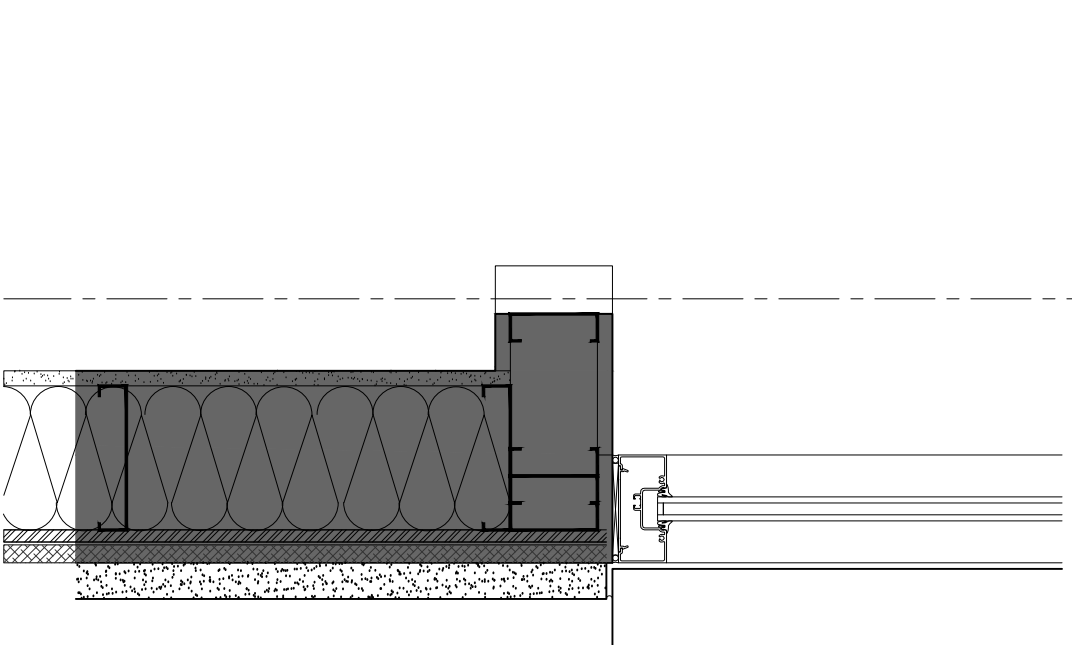

SECTION DETAIL 1 1/2"=1'-0" 18

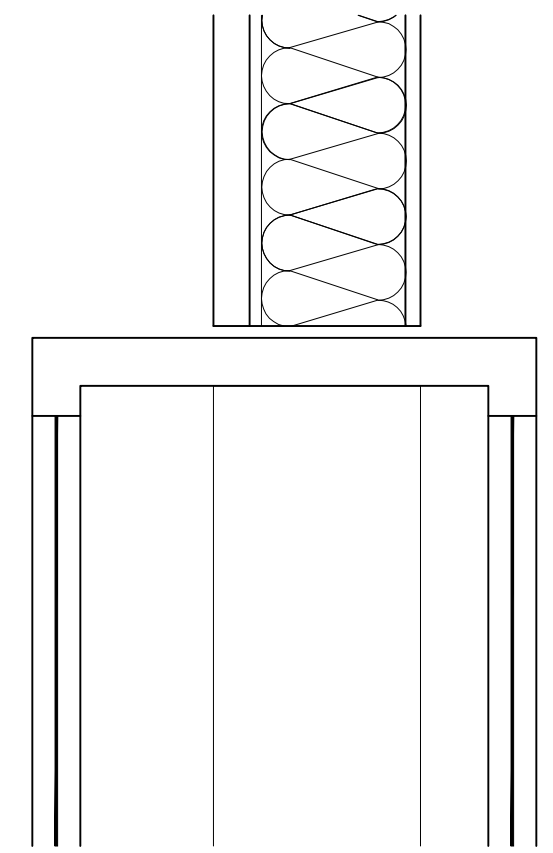

SECTION DETAIL 1 1/2"=1'-0" 14

SECTION DETAIL 1 1/2"=1'-0" 10



SECTION DETAIL 1 1/2"=1'-0" 6

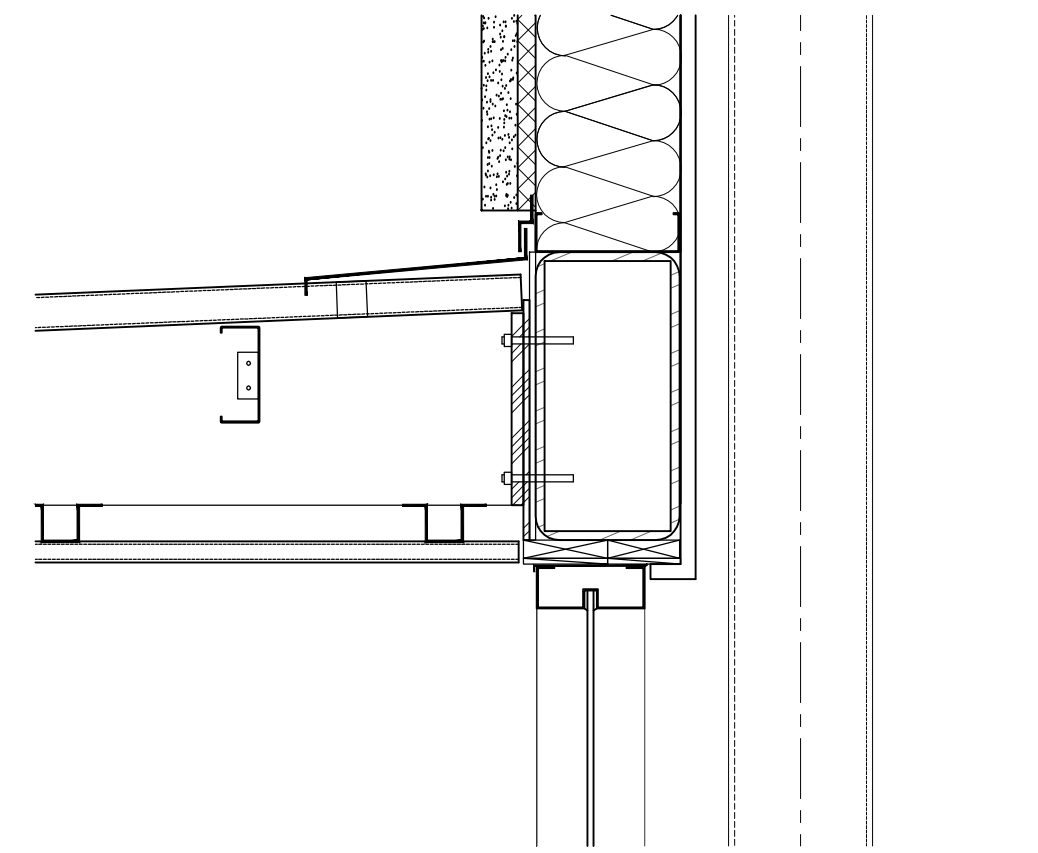

SECTION DETAIL 1 1/2"=1'-0" 2



SECTION DETAIL 1 1/2"=1'-0" 17

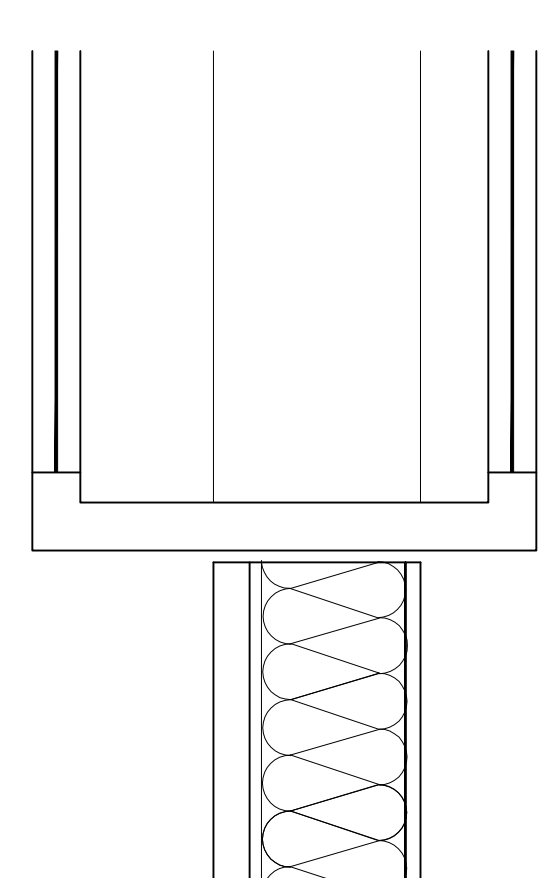

SECTION DETAIL 1 1/2"=1'-0" 13

SECTION DETAIL 1 1/2"=1'-0" 9



SECTION DETAIL 1 1/2"=1'-0" 5

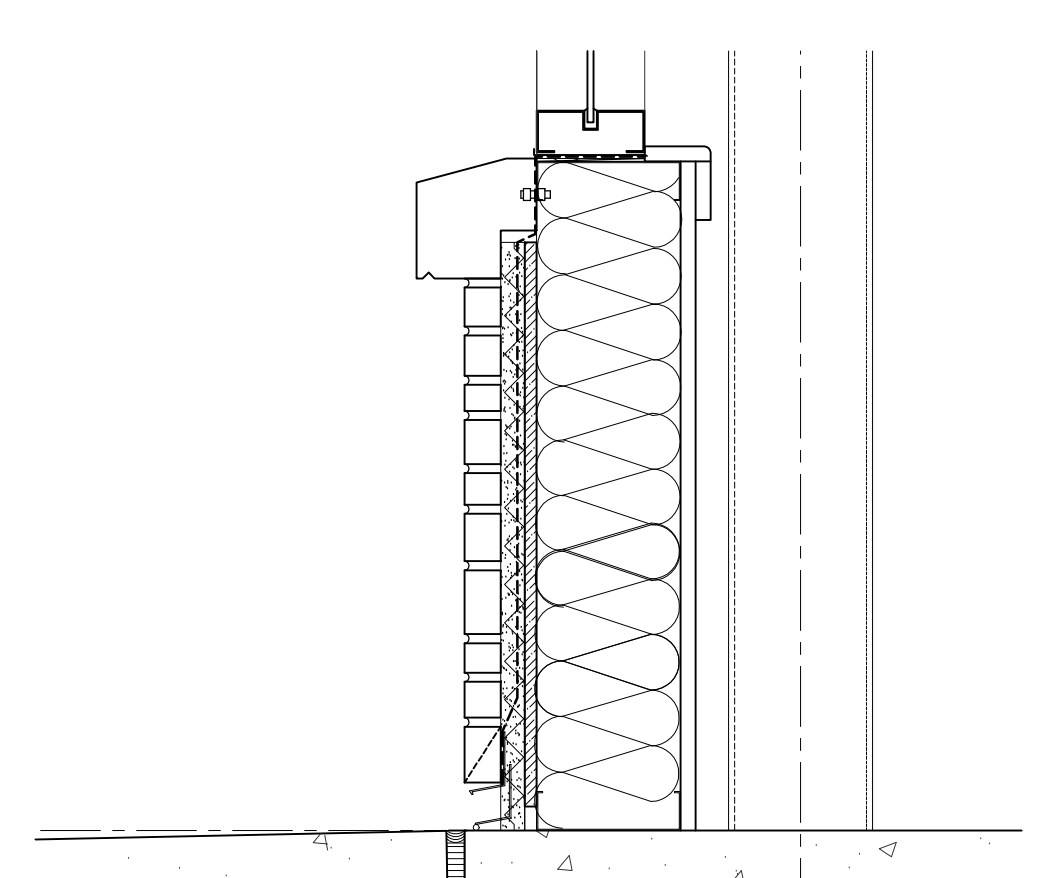

SECTION DETAIL 1 1/2"=1'-0" 1

Rev.	By	Date

SCHLOTZSKY'S
 @ VICTORY LAKETOWN CENTER
 TRACT 7A NEC INTERSTATE HWY 45 & F.M.646
 LEAGUE CITY, TEXAS 77573

ARCH[®]
 Woo Associates, LLC.
 ARCHITECTS - PLANNERS
 13734 Branford Green Dr.
 Houston, TX. 77083
 (281) 530-3192

Date	05-26-2010
Scale	AS SHOWN
Drawn by	KW
Job#:	VICTORY LAKE

A7.0