

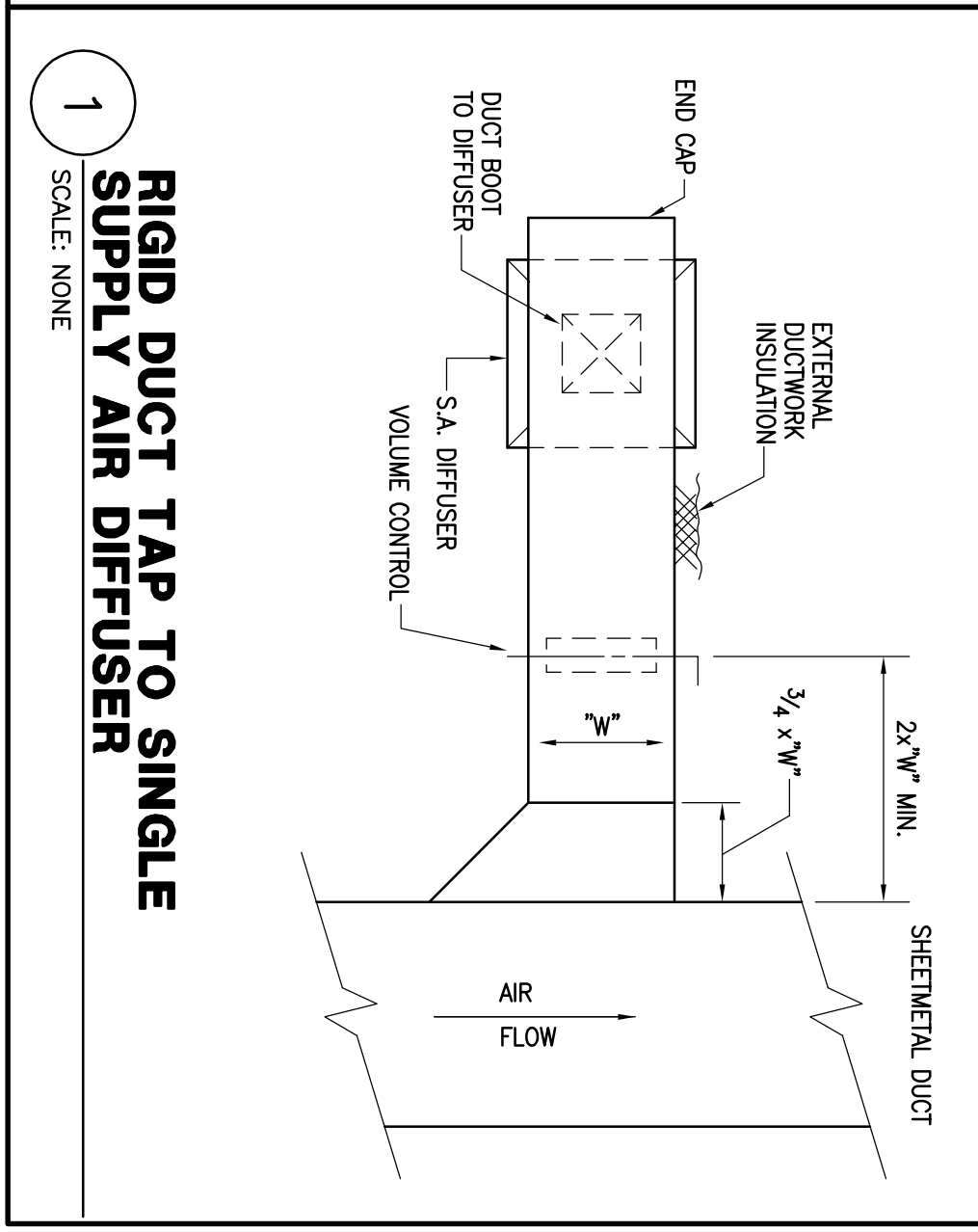

ISSUE
01/29/12 ISSUED FOR PERMIT
02/16/12 ISSUE FOR BID

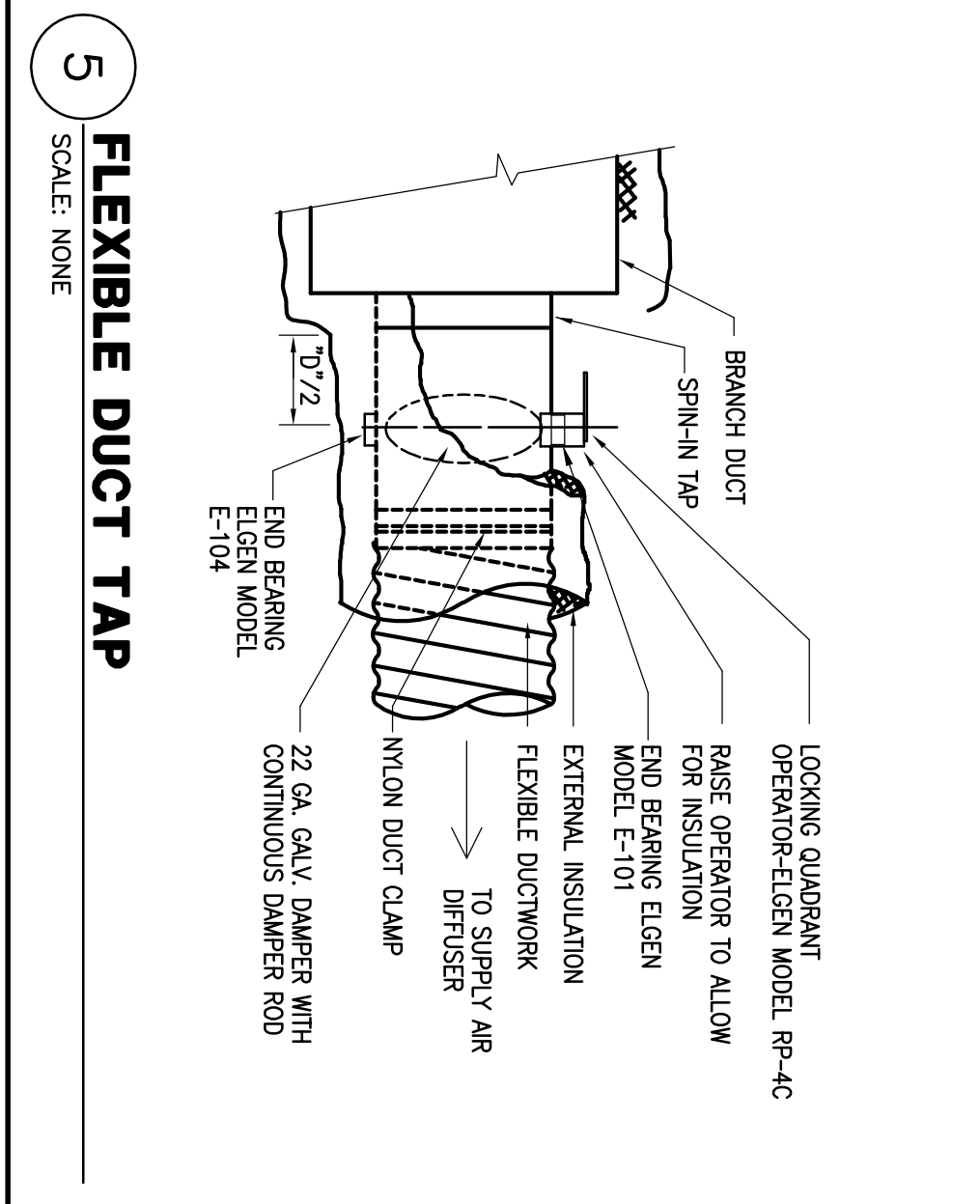
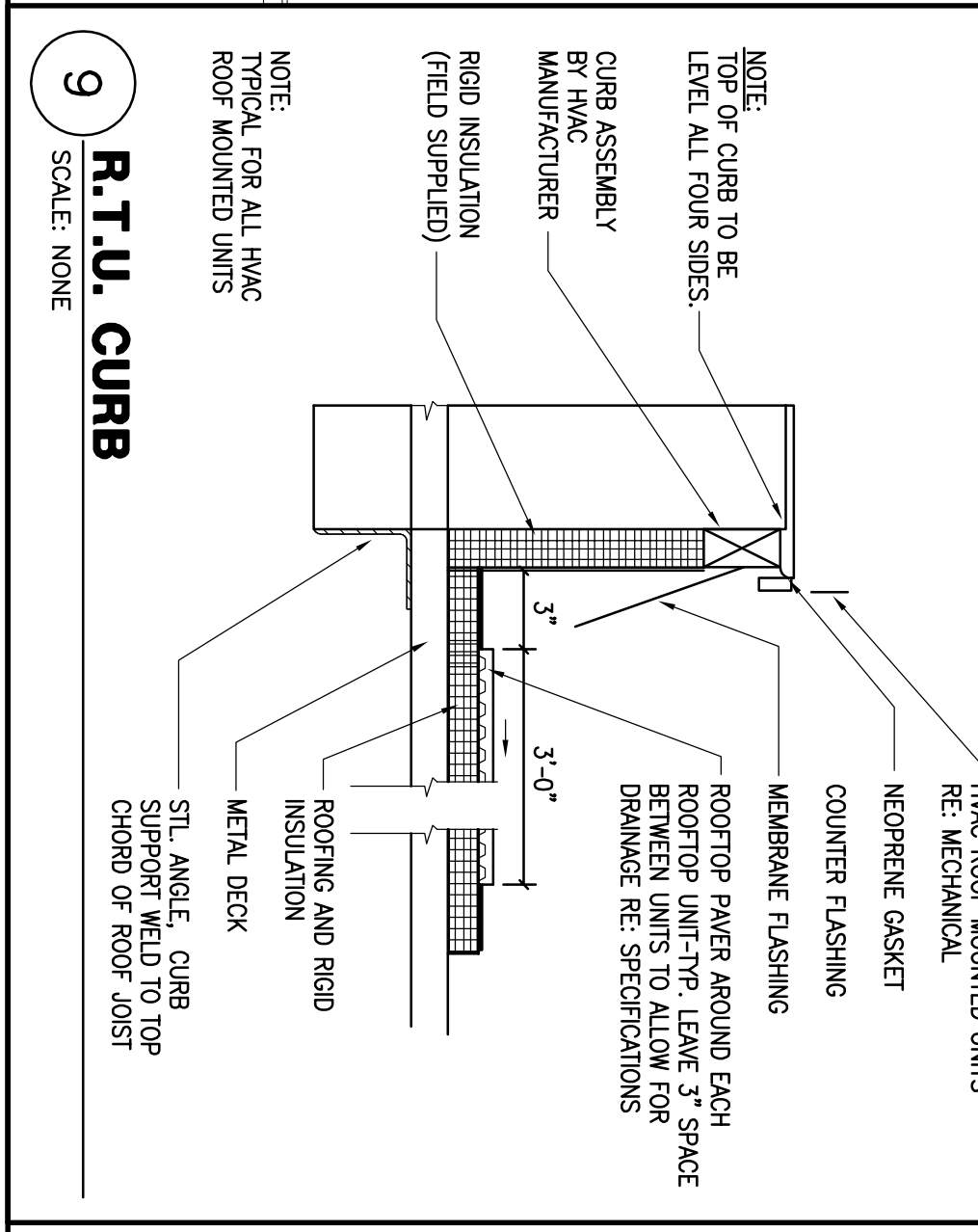
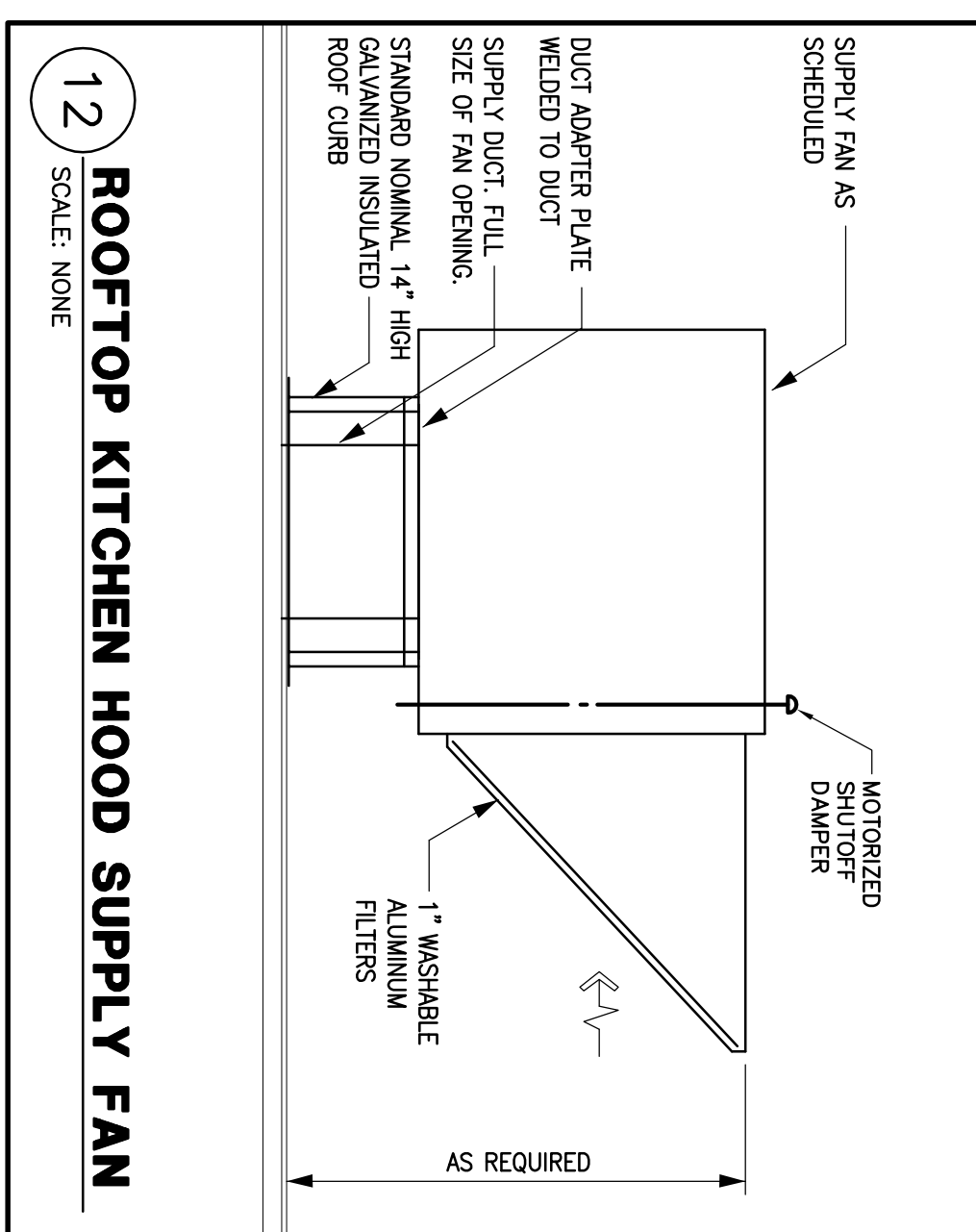
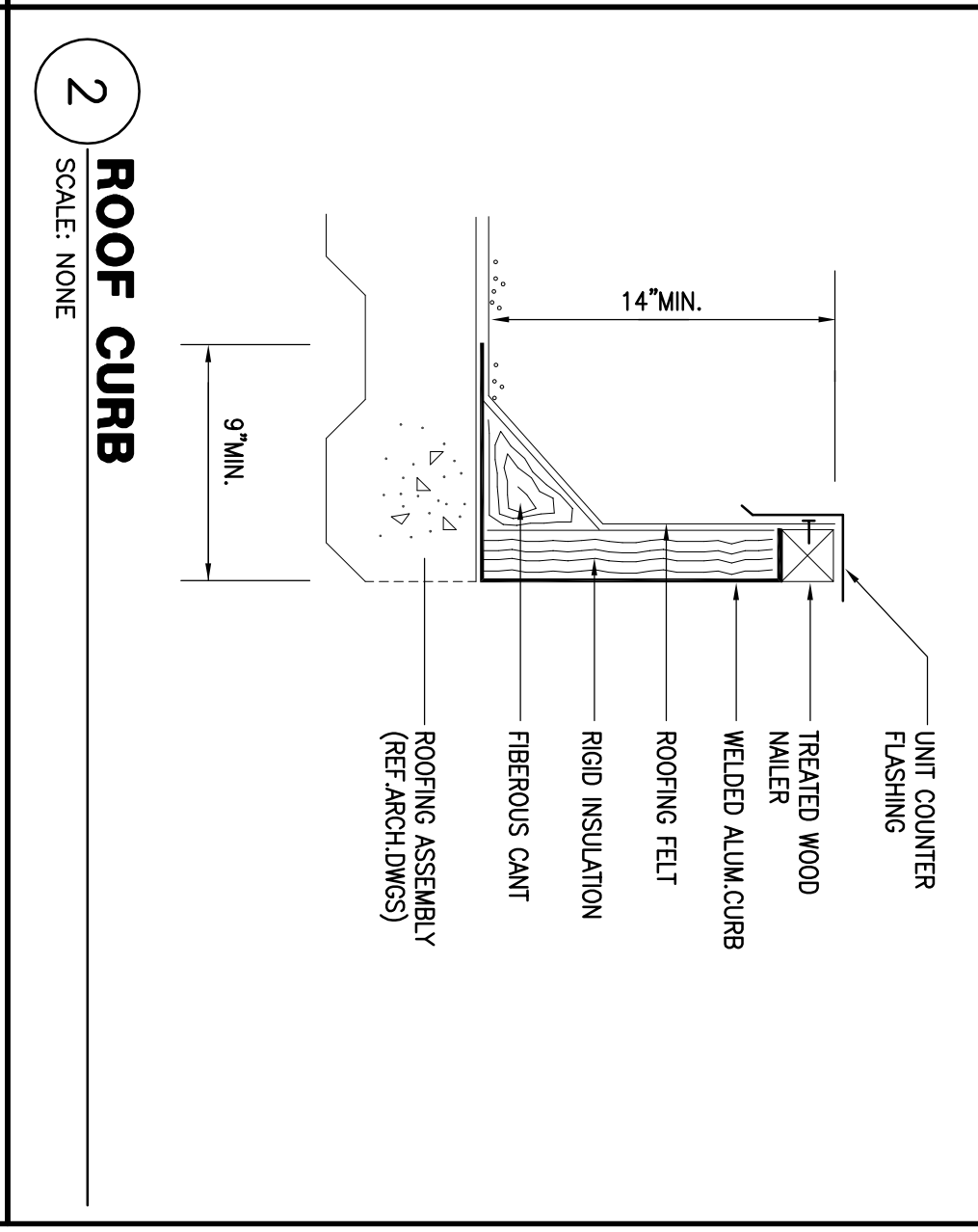
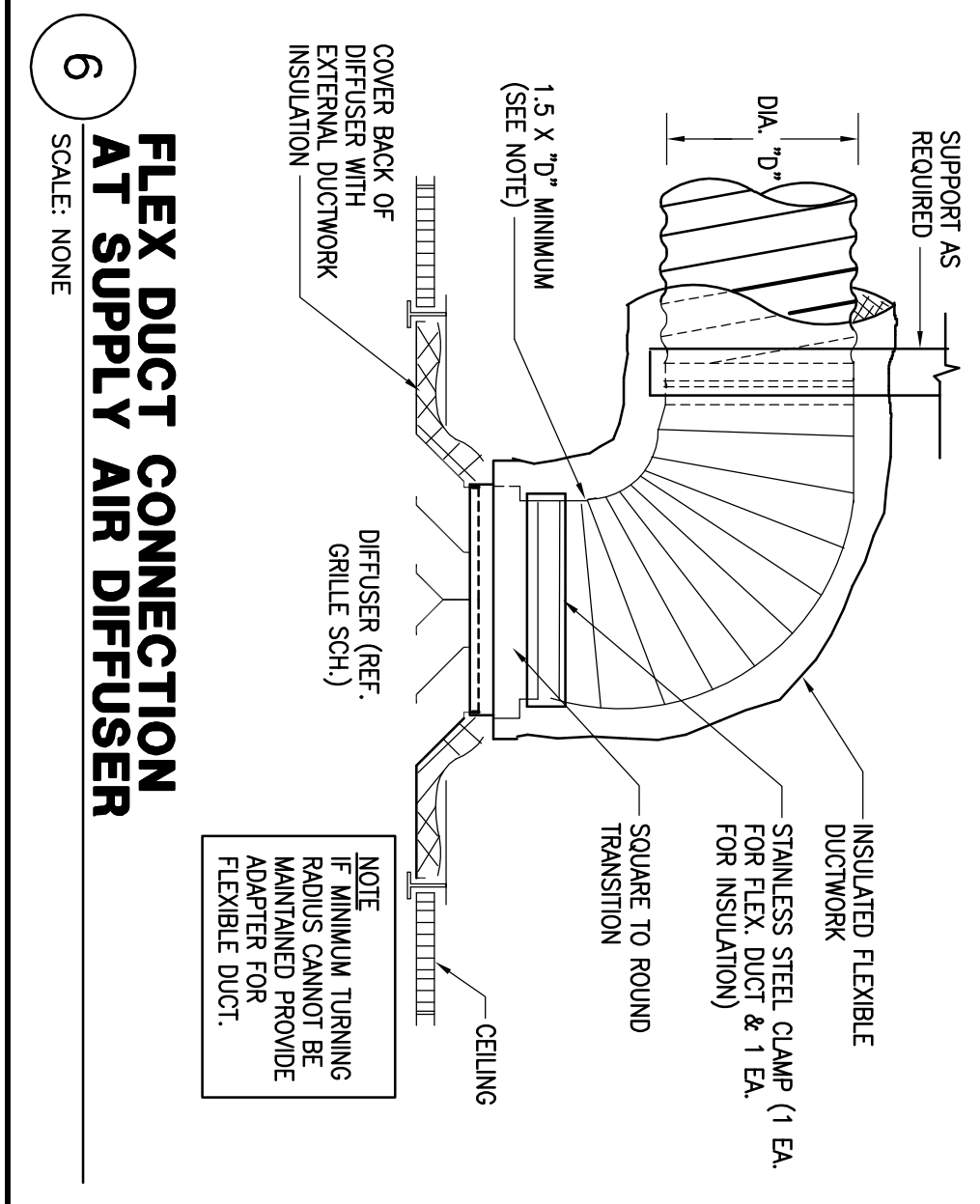
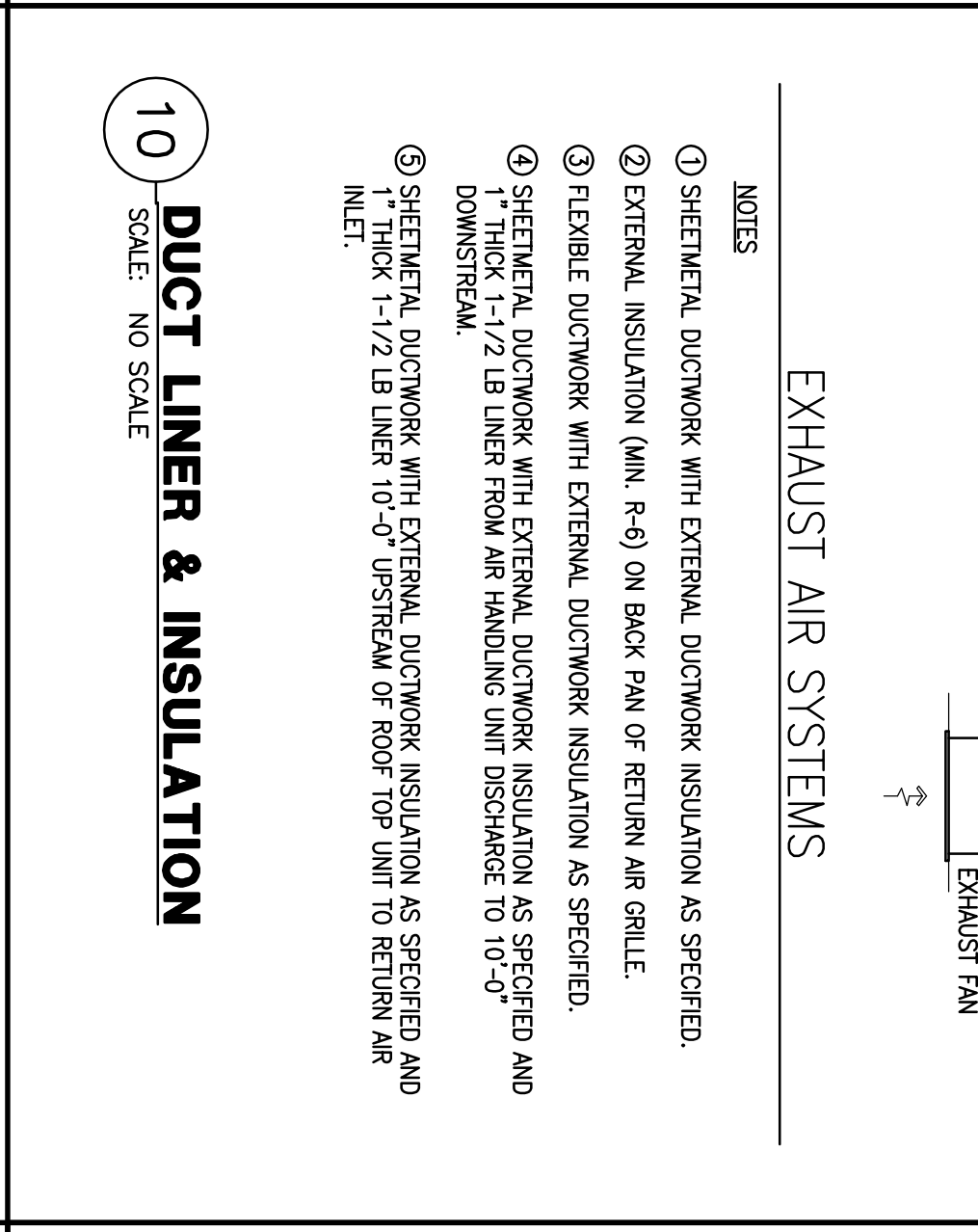
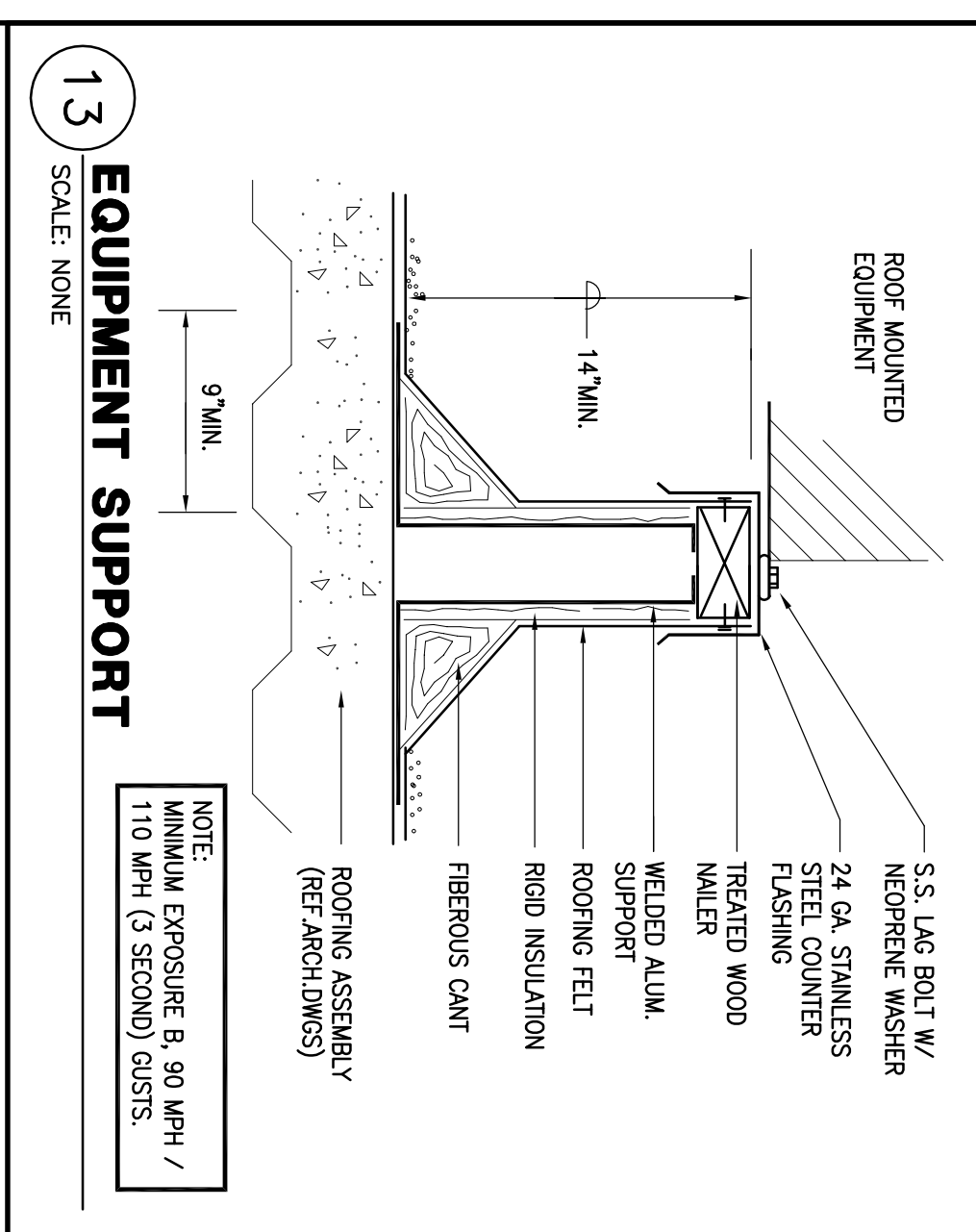
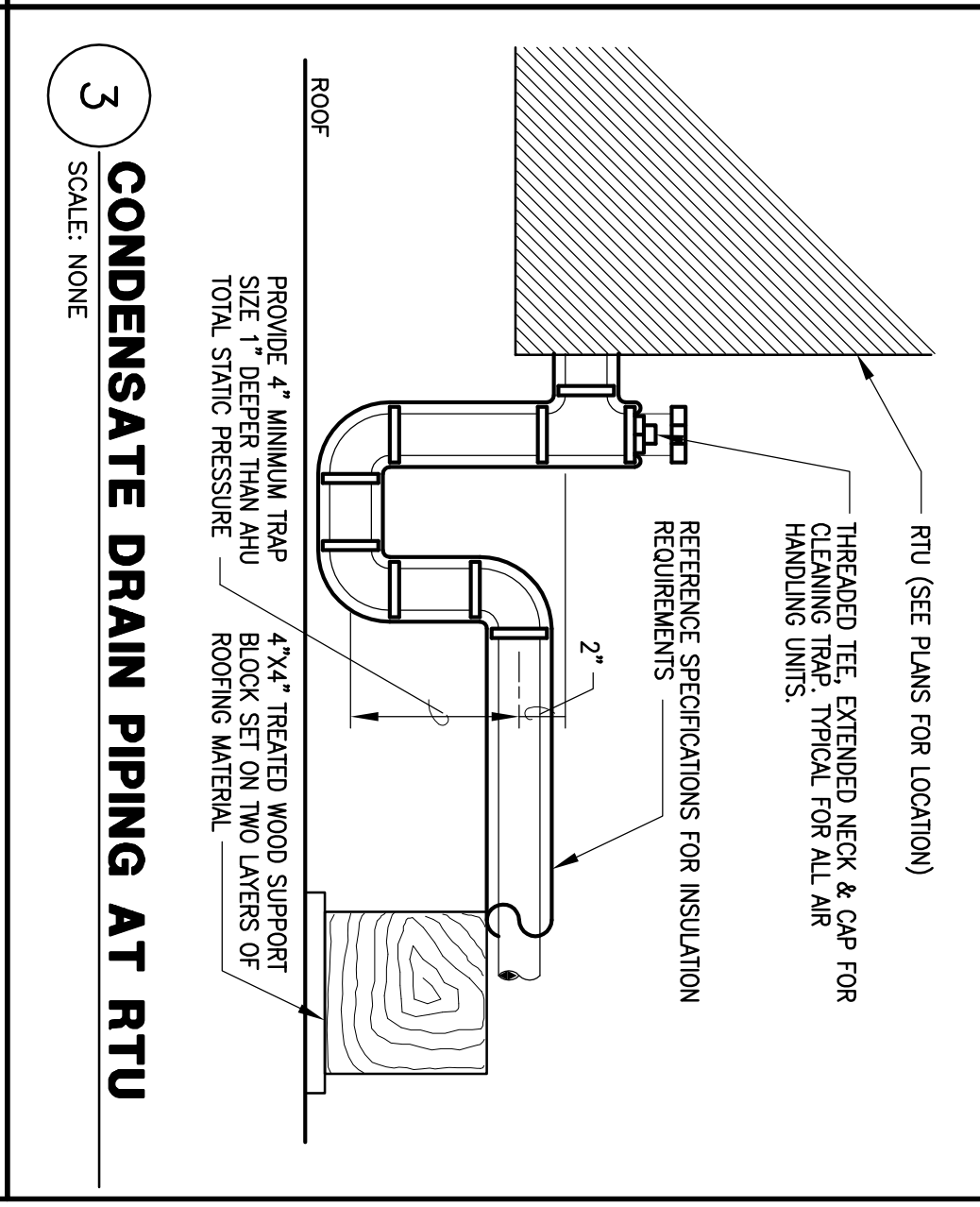
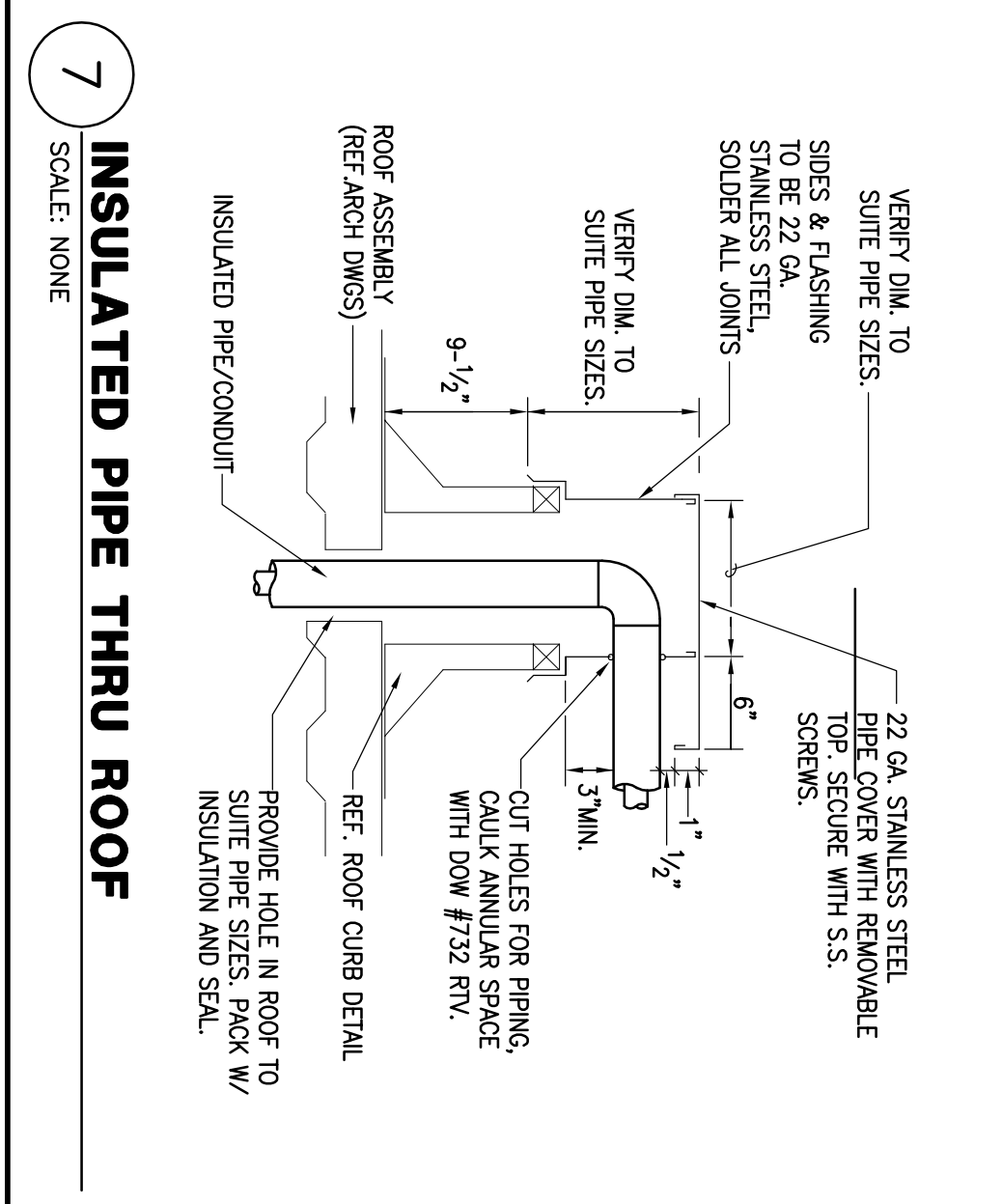
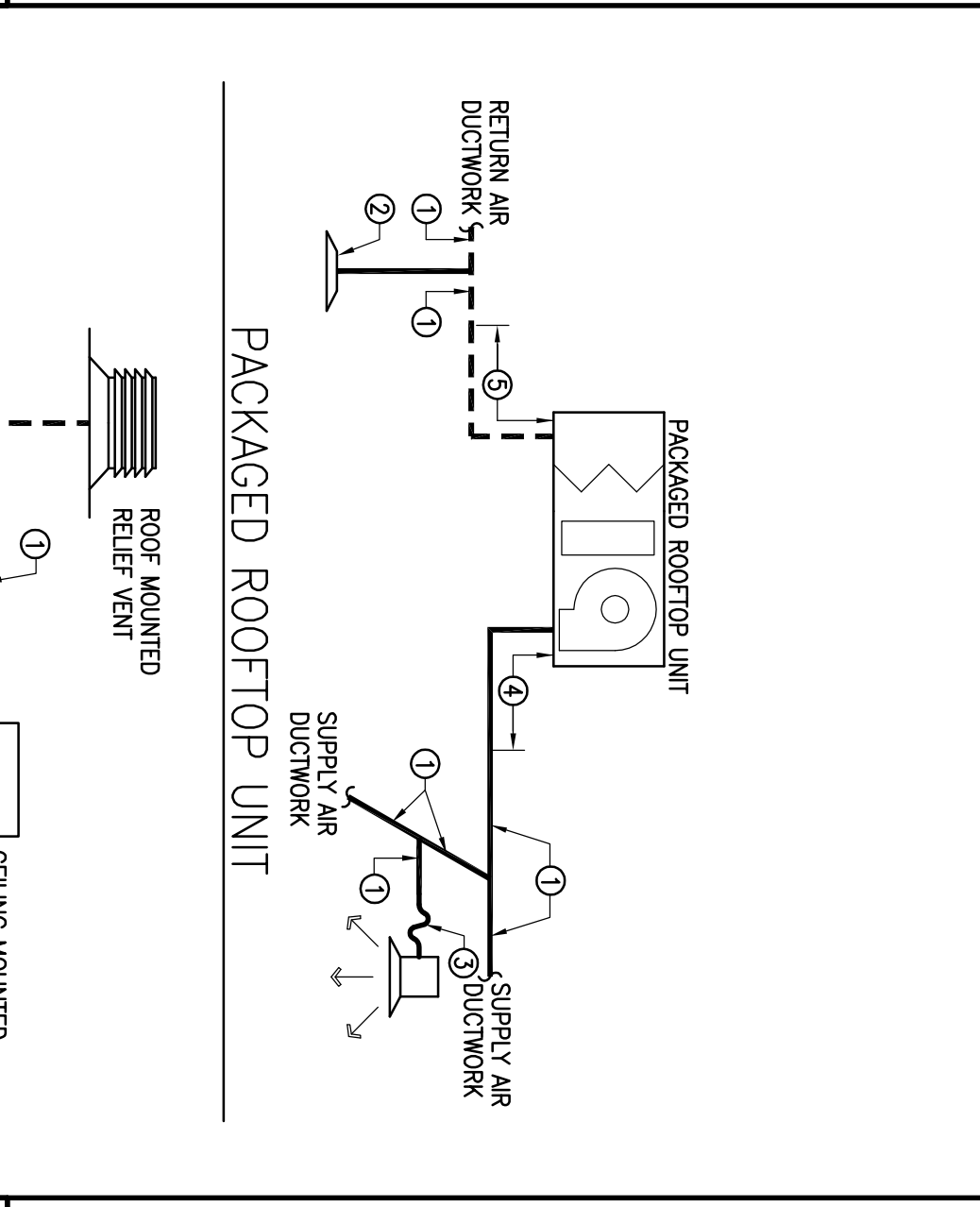
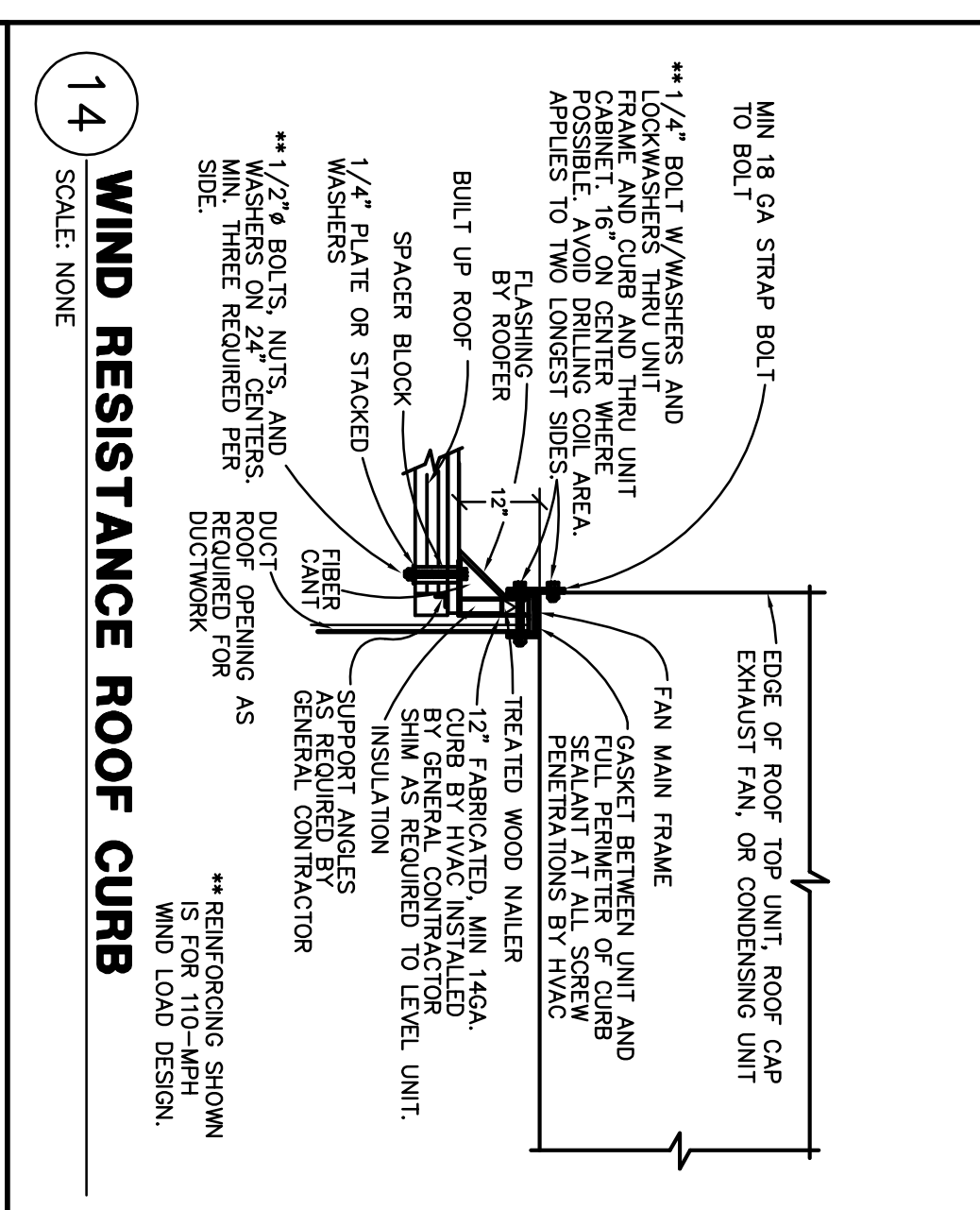
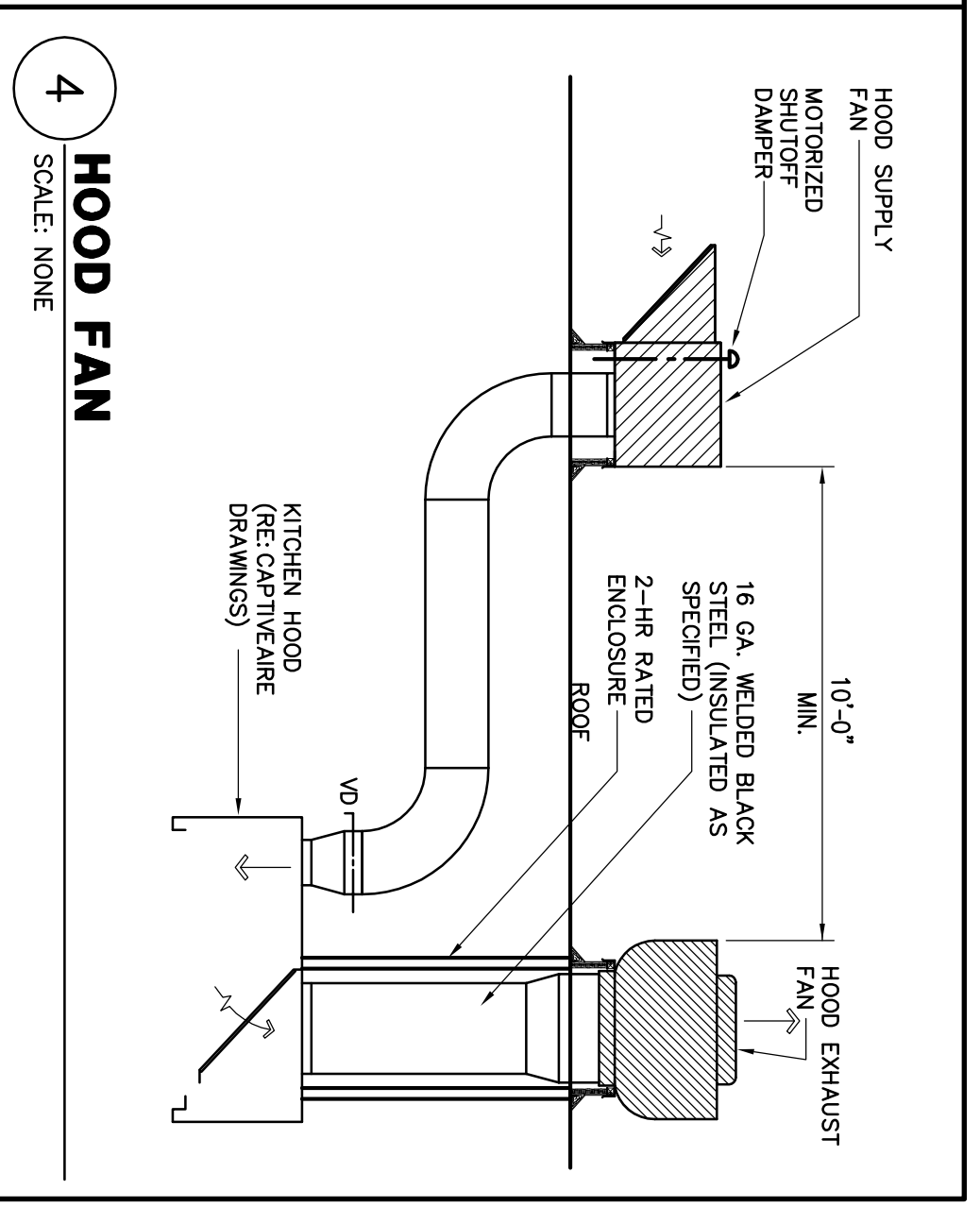
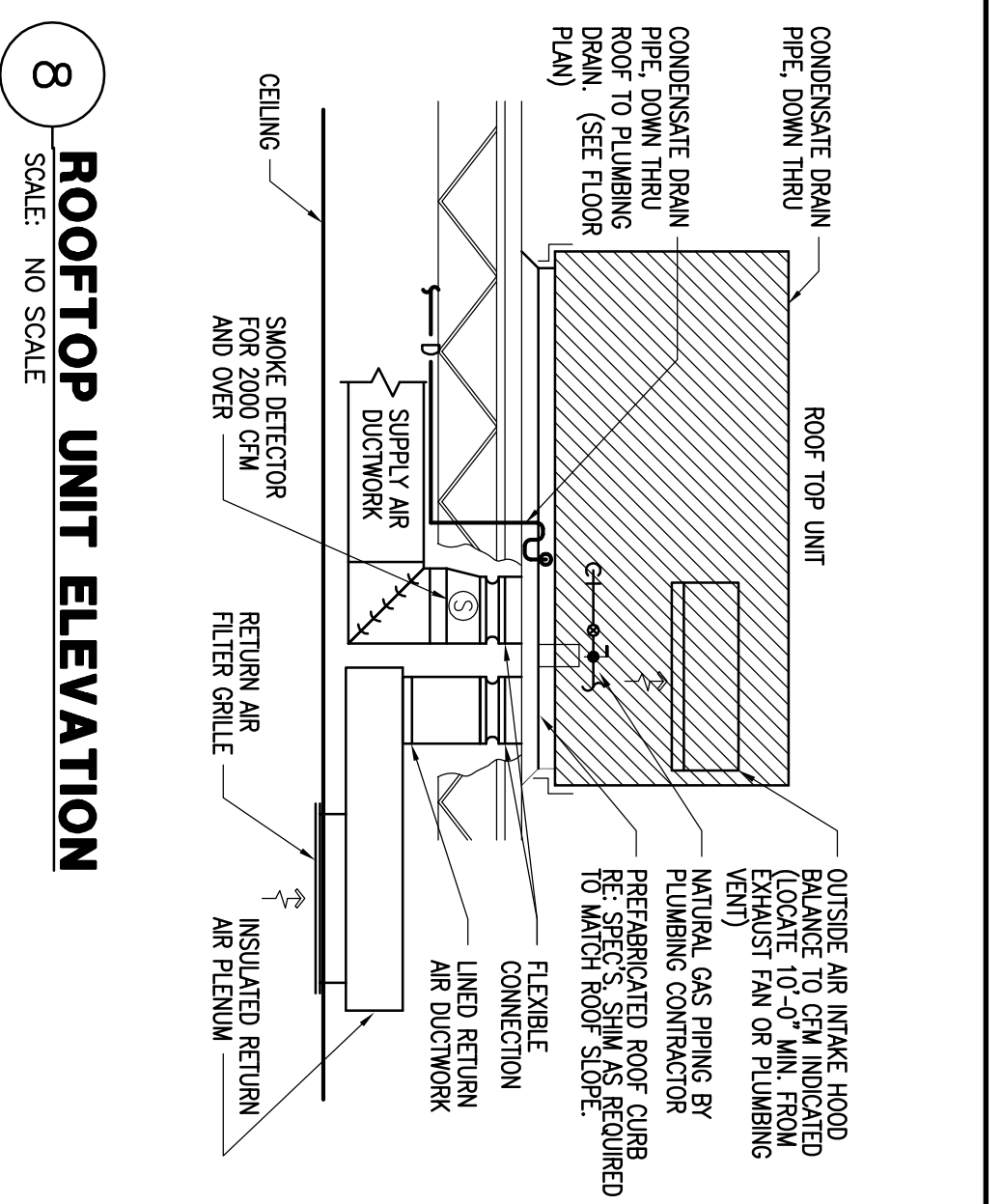
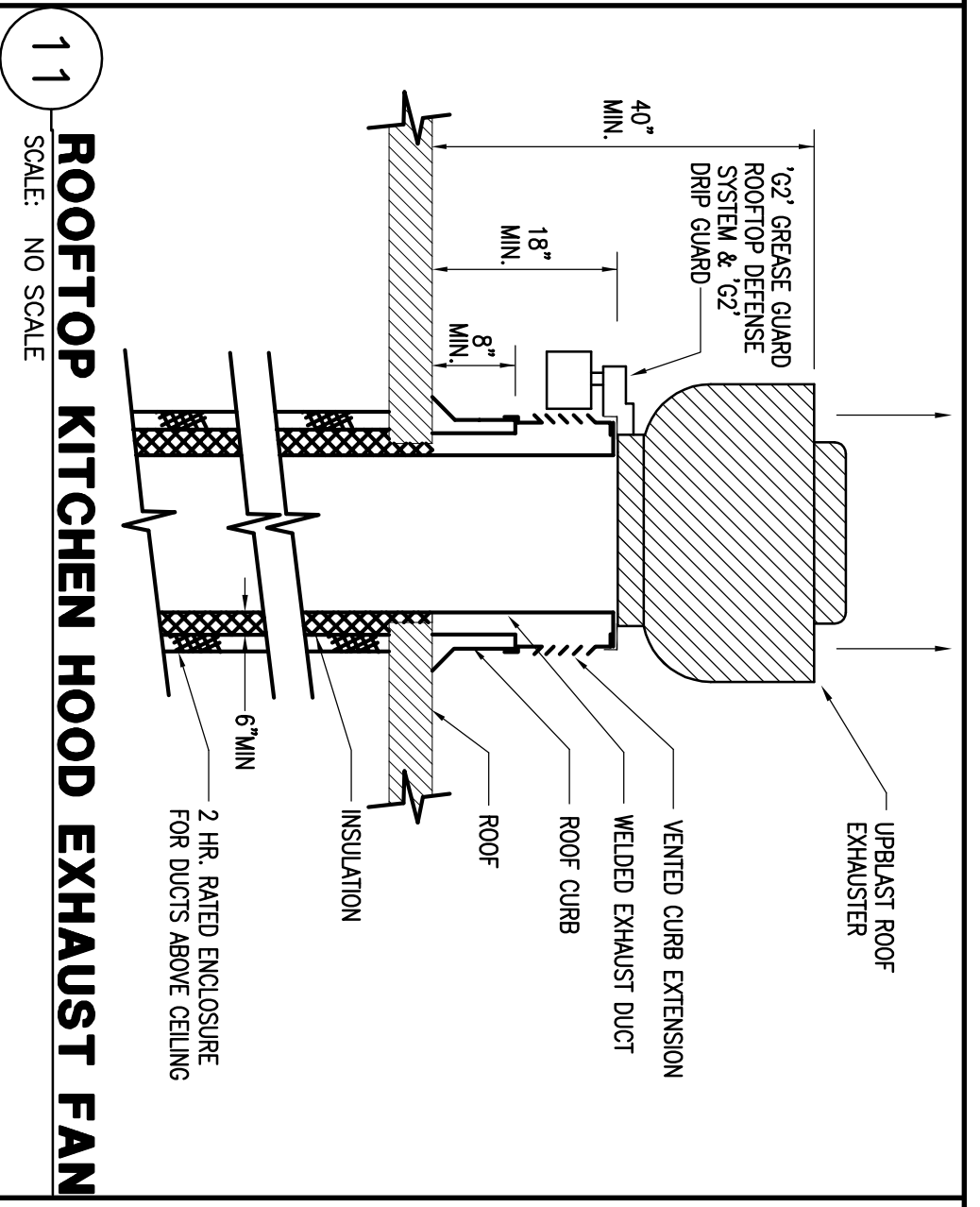
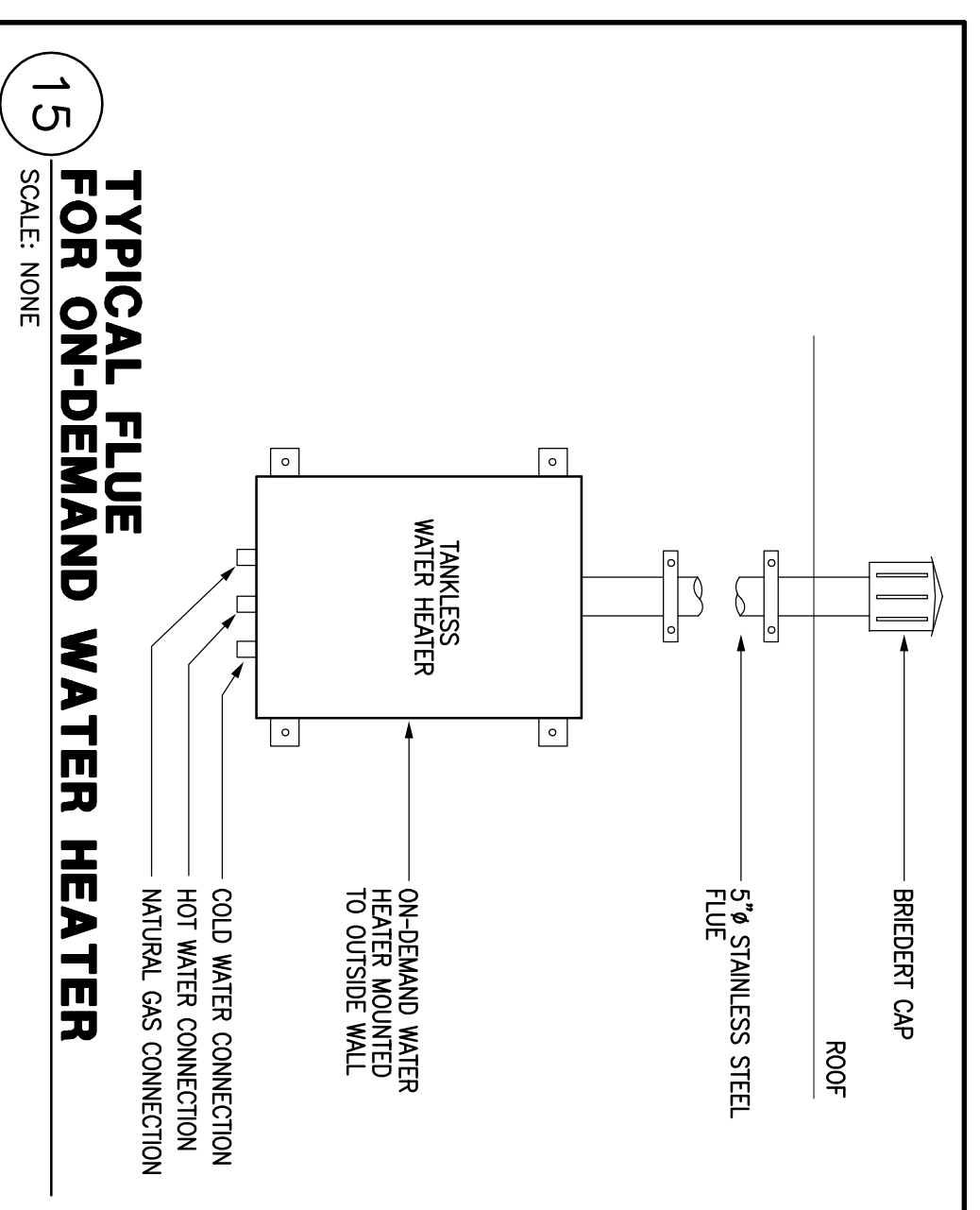

HARRELL
ARCHITECTS, LP
9575 Katy Fwy., #200
Houston, Texas 77024
Tel: 713.722.7071
Fax: 713.722.7072

Hobbs & Associates, Inc.
Consulting Engineers - Texas Reg. 15-343
6671 Southwest Fwy., Suite 850
Houston, Texas 77074 (713) 995-1351
www.hobbsandassociates.com
Contact: Bob Schmitt (832) 949-0898

PROJECT NAME
Maharaja Bhog

PROJECT ADDRESS
8338 Southwest Freeway
Houston, Texas 77074

PROJECT NUMBER
11078
SHEET NAME
**MECHANICAL
DETAILS**
SHEET NUMBER
M2.1